

Montagehandleiding Fitting instruction Anbauanweisung Description de montage Instrucciones de montaje Montagevejledning Monteringsveiledning Monteringsanvisning	Laguna II Break 2000 →	Typegoedkeuringsnr. Prüfungsnr. Approval number Numero d'homologation Homologación de tipo n° Nr. typegodkendelse Typegodkjennelsesnumm Typgodkannandennummer	Max. toegestaan voertuiggewicht Zul.Kfz.-Gesamtgewicht Max.permissible weight towing vehicle Poids max. autorise du vehicule Peso máximo admisible del vehiculo Højst tilladte køretøjsvægt Maks tillatt kjøretøyvekt Max tillaten fordonsvikt	Max.massa a.h.w. Max. Anhängelast Max. trailer weight Poids tractable maxi Peso posterior de mas a máximo Maksimal pahaengsvægt Maks masse tilhengsvækt Max. sl pvagnsvikt	Max.verticale last Max. Stützlast Max. nose weight Charge vertical Carga vertical Maksimal lodte Maks. vertikal Max. kultryk	D waarde D Wert D value valeur de D Valor D D-værdi D-verdi D-värde	<table border="1"> <tr> <td>NL</td> <td>D</td> <td>GB</td> <td>N</td> </tr> <tr> <td>F</td> <td>E</td> <td>DK</td> <td>S</td> </tr> </table>	NL	D	GB	N	F	E	DK	S
		NL	D	GB	N										
F	E	DK	S												
027101 TYPE : 027102 027103	e4*94/20*1687*00 e4*94/20*1756*00 e4*94/20*1757*00	2055Kg	1500Kg	75Kg	8,51kN	© BOSAL le 26/02/2001									

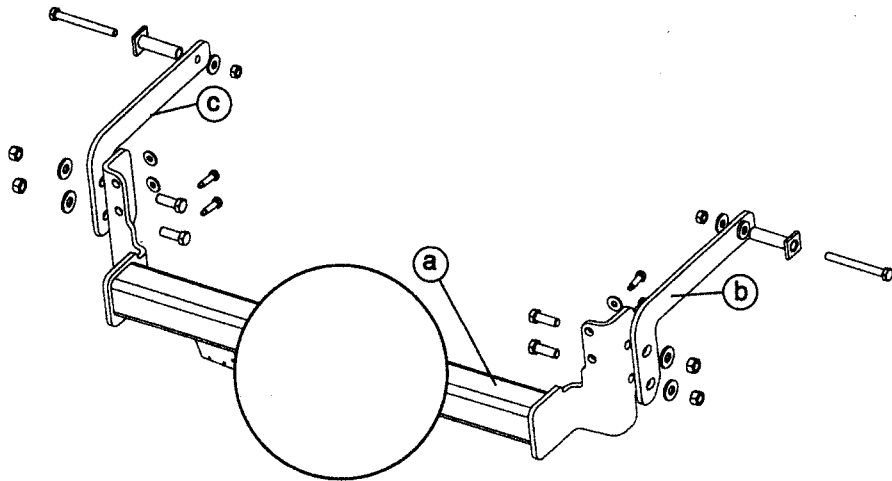

Raadpleeg uw dealer voor de max.massa die uw wagen trekken.

Die maximale Anhängelast Ihres Fahrzeuges können Sie im Fahrzeugschein oder im Benutzerhandbuch nachlesen.

For the max.trailer weight of your car please refer to the owner's manual documents.

Pour connaître le poids maxi remorquable pour votre voiture consulter la notice de votre voiture ou la carte grise.

Consulte a su distributor sobre el peso máximo que puede remolacar su vehiculo

Deres forhandler vil kunne oplyse Dem om den højst tilladte vægt efter D

Ta kontakt med forhandleren angående den maksimale massen som bilen kan trekke

Radgör med din återförsäljare för bilens maximala dragvikt.

Meegeleverde onderdelen
Mitgelieferte Befestigungsteile
Provided parts
Materiel de fixation joint
Piezas incluidas
Medfølgende komponenter
vedlagt festemateriel
Medföljande monteringsmaterial

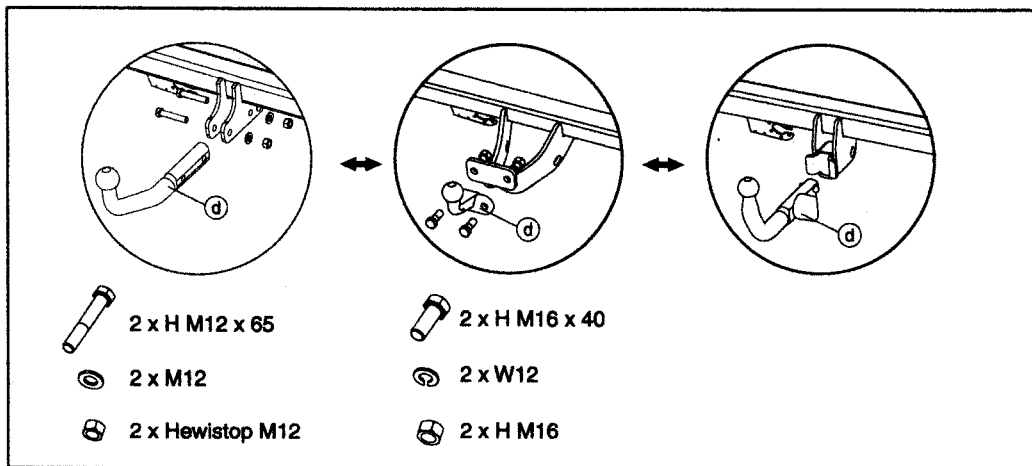

4 x H M8 x 25
4 x H M12 x 1,25 x 35
2 x H M10 x 100

2 x H M10
4x H M12

4 x CL8
2x CL10
4 x CL12

2 x

bosal

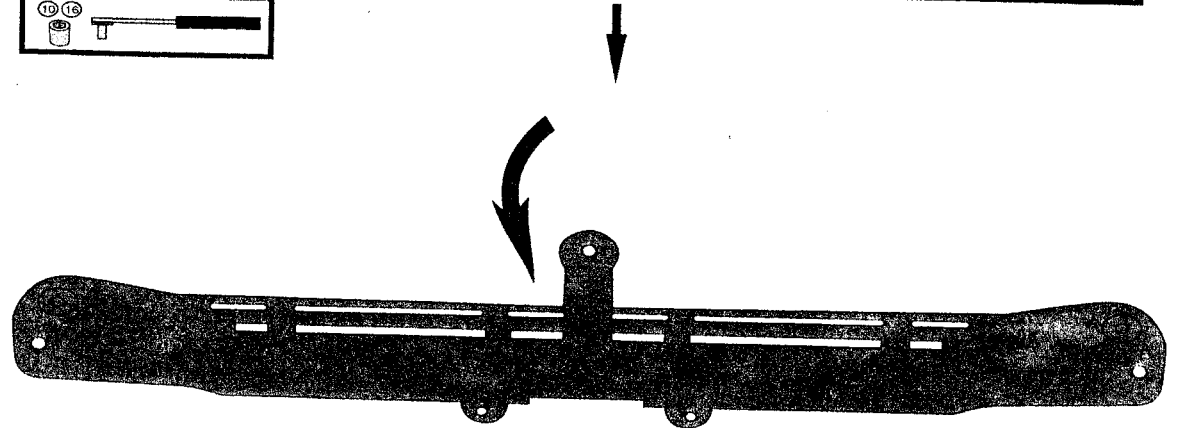
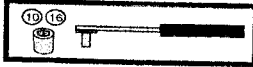
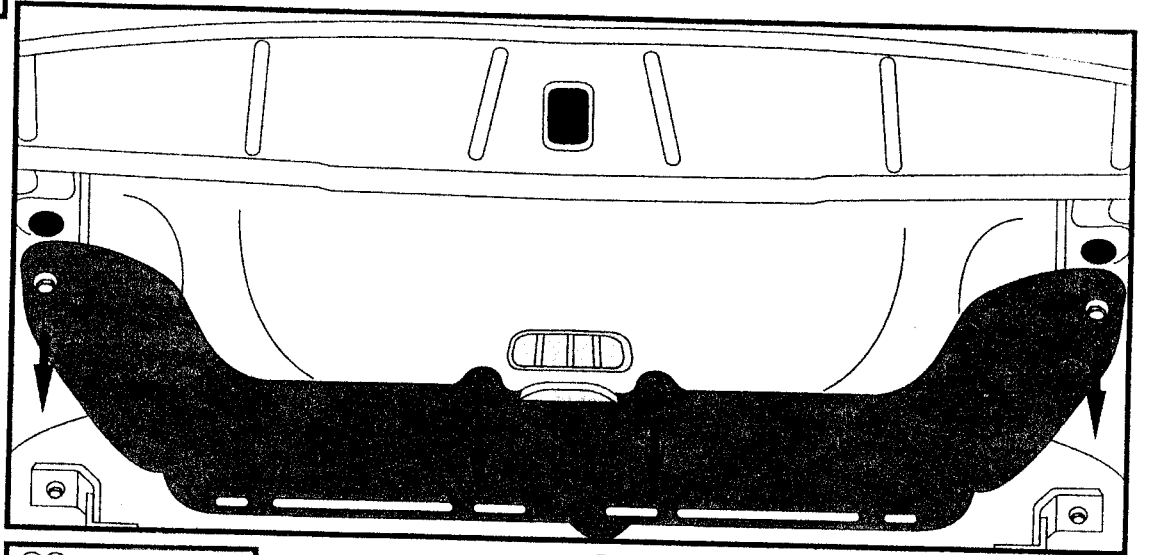
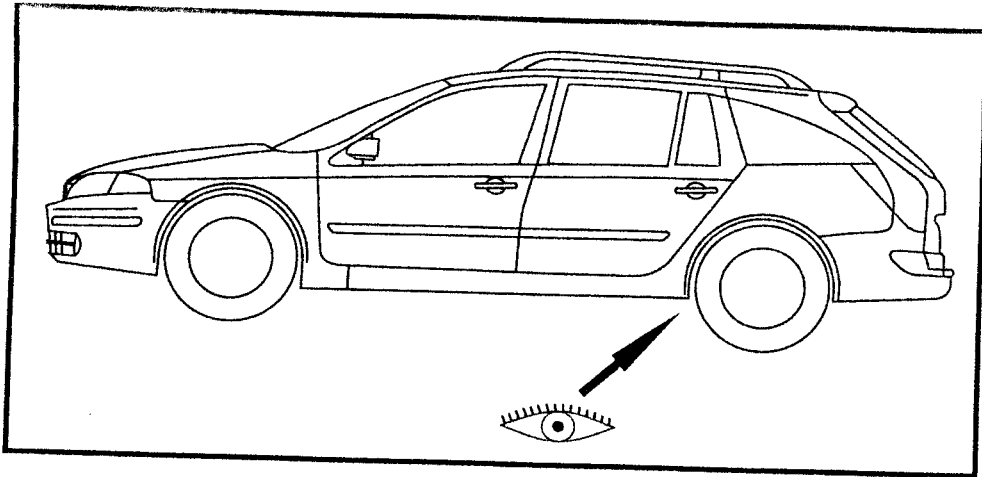

Laguna II Break

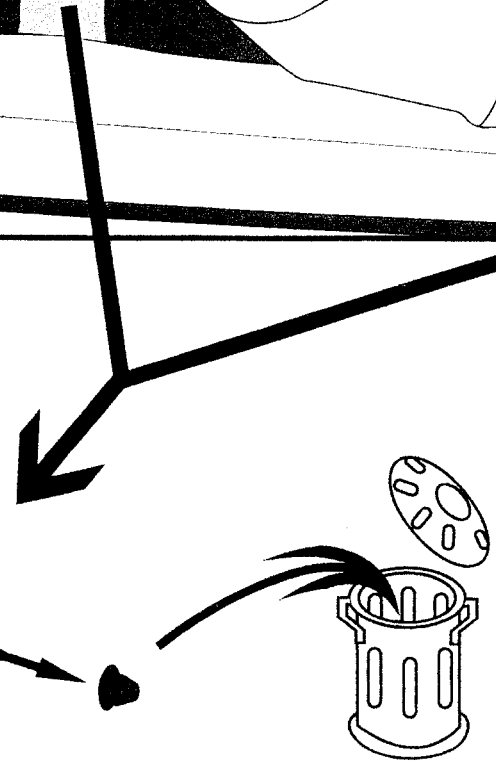
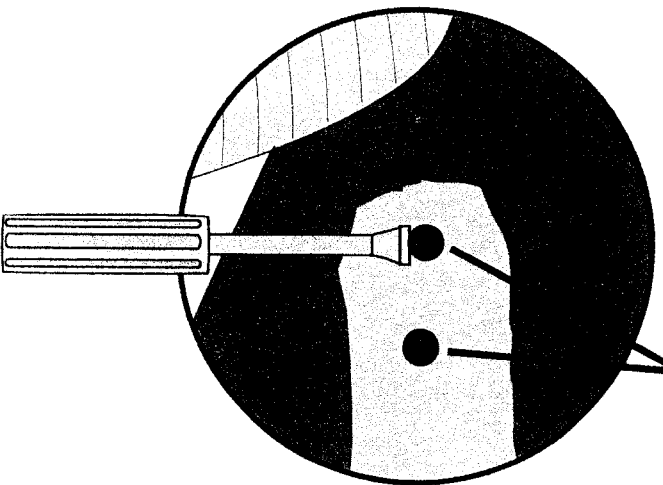
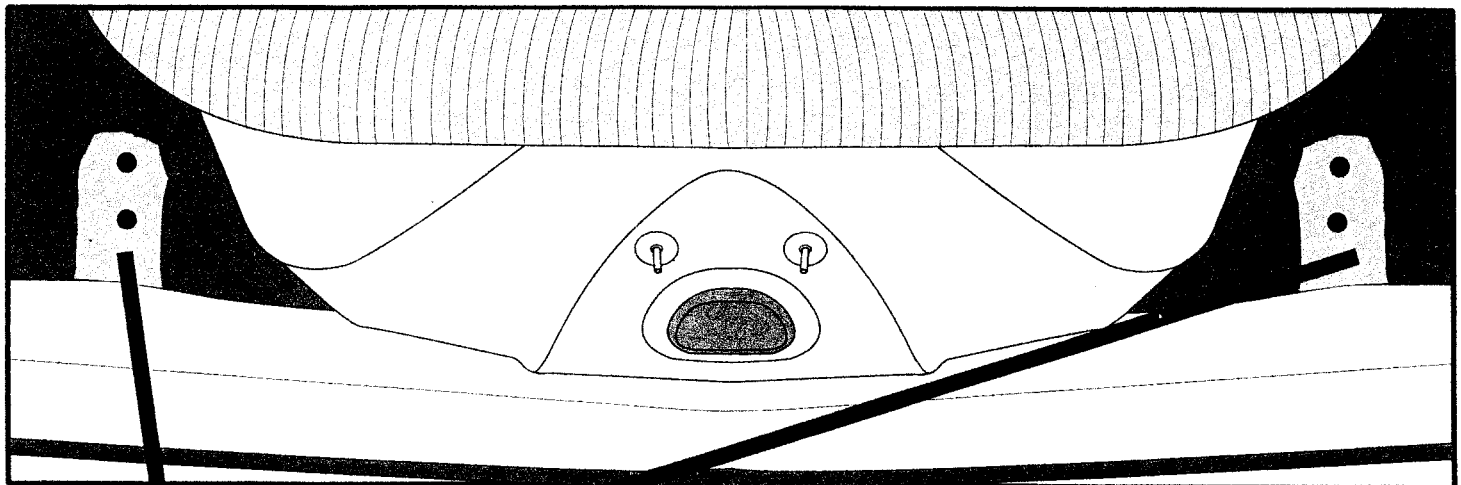
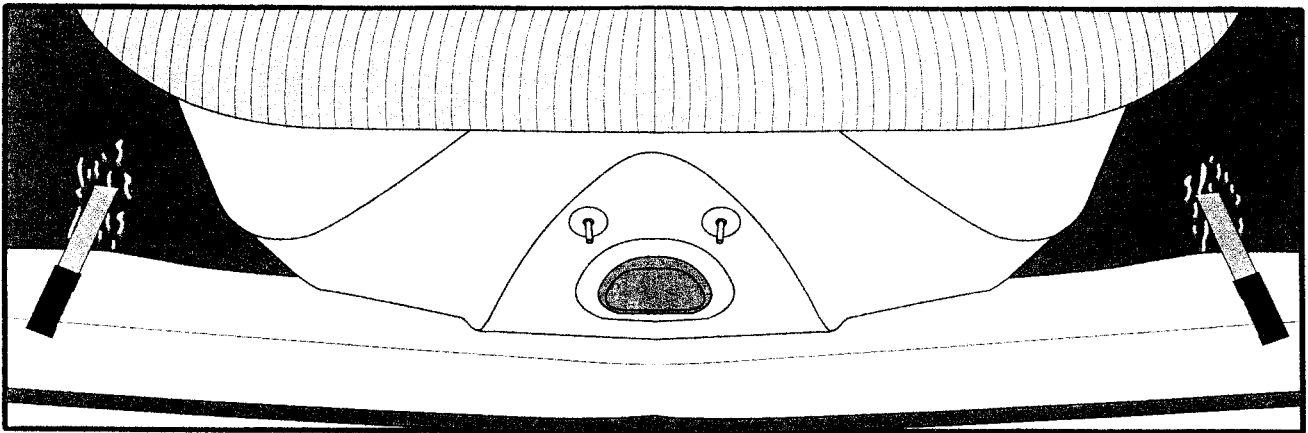

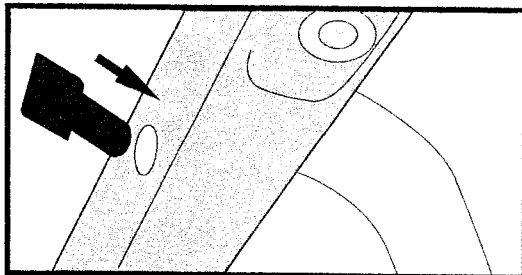
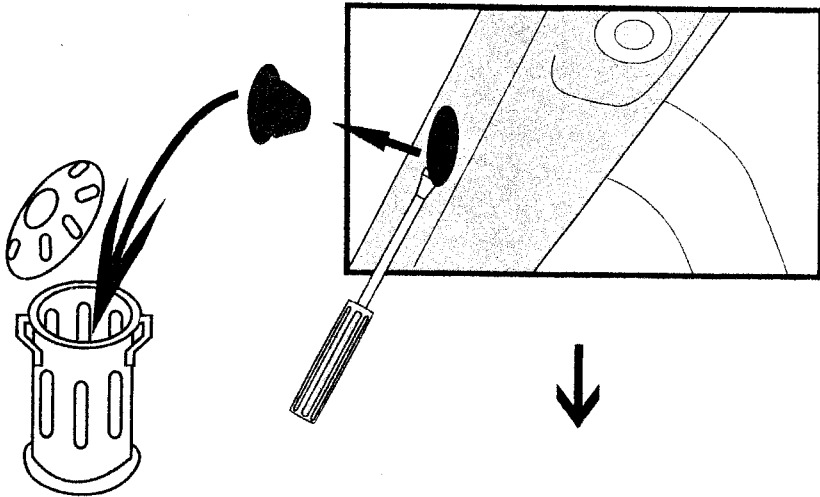
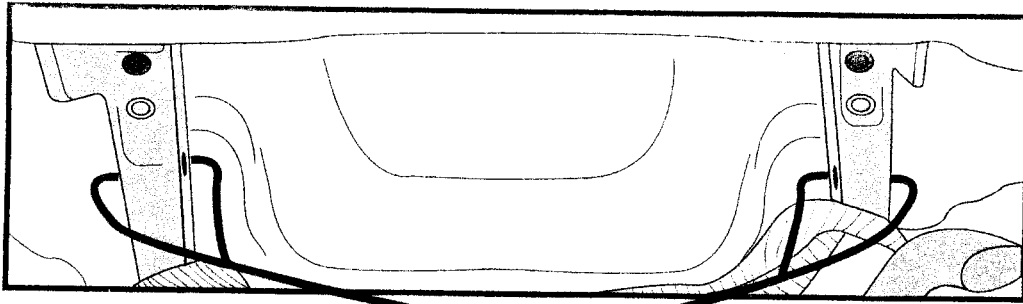



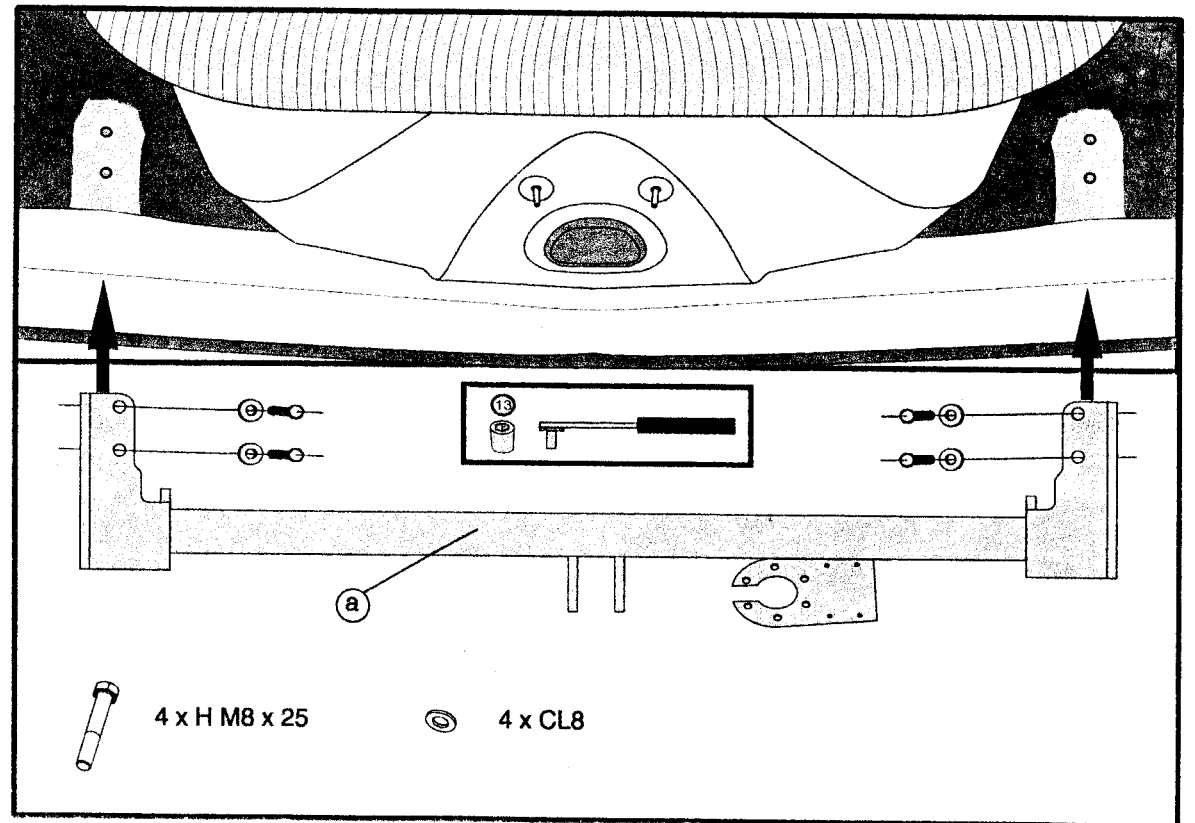

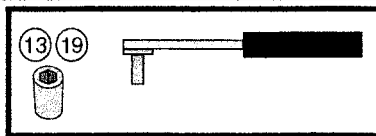
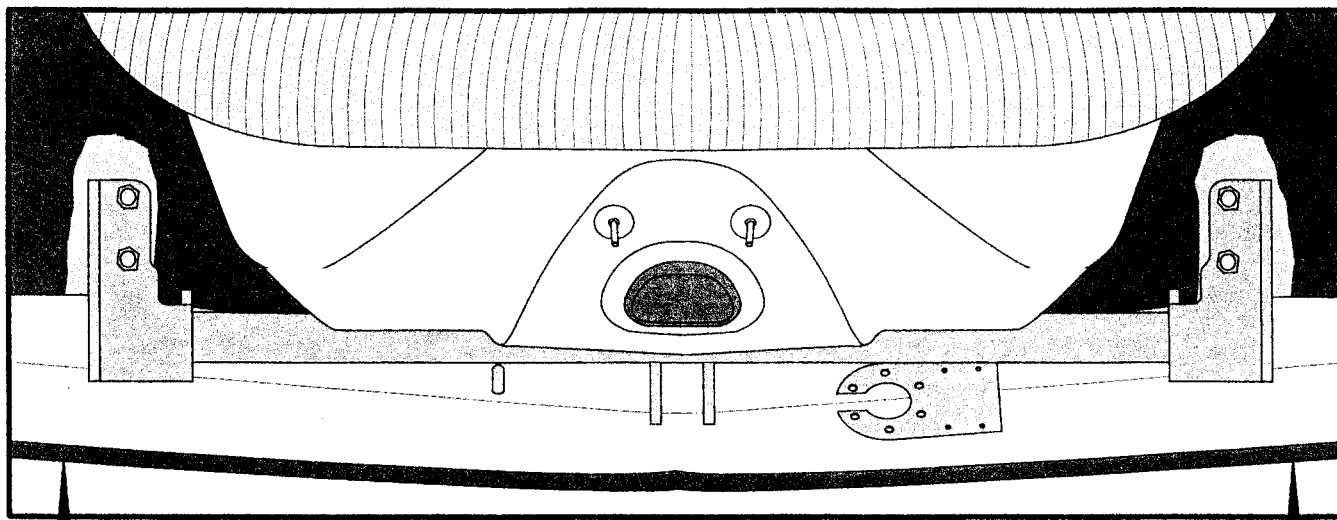

 2 x





 4 x H M12 x 1,25 x 35
 2 x H M10 x 100

 2 x CL10
 4 x CL12

 2 x H M10
 4 x H M12

